



Verðlisti og upplýsingar um viftur og stýringar september, 2024

Vörunúmer	Stærð	Afköst 0 Pa	Amper	Kw	Verð án /vsk	Verð m/vsk
Háhraða viftur						
MF4E-30Q	30 cm	2.300m ³	0,5	0,1	78.210,-	96.980,-
MF4E-35Q	35 cm	3.500m ³	0,9	0,17	86.274,-	106.980,-
MF4E-40Q	40 cm	4.900m ³	1,1	0,24	87.887,-	108.980,-
MF4E-45Q	45 cm	6.550m ³	1,6	0,32	99.984,-	123.980,-
MF4E-50Q	50 cm	8.300m ³	2	0,44	108.048,-	133.980,-
Lághraða viftur						
MF6E-50Q	50 cm	5.600m ³	1,5	0,31	123.371,-	152.980,-
MF6E-56Q	56 cm	8.350m ³	2,4	0,53	147.565,-	182.980,-
MF6E-63Q	63 cm	11.500m ³	3	0,6	154.916,-	190.980,-
MF6E/71Q	71 cm	13.500m ³	3	0,63	196.790,-	208.980,-

Hraða og hitastýringar

Vörunúmer	Vörulýsing	Amper	Verð án /vsk	Verð m/vsk
MFEW5	Hraðastýring EW 5Amp	5	28.218,-	34.990,-
MFEW10	Hraðastýring EW 10 Amp	10	32.250,-	39.990,-
MFAEW10D	Hita og hraðastýring AEW 10D	10,0	120.383,-	149.275,-
MFSEA3.0	Þrepastýring, 3.0 AMP	3,0	40.242,-	49.990,-
MFSEA6.0	Þrepastýring 6.0 AMP	6,0	48.306,-	59.990,-
MFT15-WD	Hitastýring T15-WD		8.056,-	9.990,-
MFT15-2	Hitastýring T15-2		24.185,-	29.990,-
MFT15-4	Hitastýring T15-4		32.177,-	39.990,-

Hitanemar

Vörunúmer	Vörulýsing	Verð án /vsk	Verð m/vsk
MFNTC-5	Hitanemi fyrir AEW-10D - svartur	5.637,-	6.990,-
MFNTC-6	Hitanemi fyrir AEW - 6,3D - blár	7.653,-	9.490,-

Lífland áskilur sér rétt til verðbreytinga án fyrirvara



Viftur og stýringar fyrir gripahús

Mál í mm

Tegund	A	B	C	D	E	G
MF4E-30Q	395	442,5	340	192	84	8
MF4E-35Q	445	492,5	390	192	84	8
MF4E-40Q	495	542,5	440	192	84	8
MF4E-45Q	545	592,5	490	192	84	8
MF4E-50Q	600	647,5	540	192	84	8
MF6E-50Q	600	647,5	540	247	105	10
MF6E-56Q	640	700	600	247	105	10
MF6E-63Q	715	775	670	247	105	10
MF6E/71Q	790	850	742	247	105	10

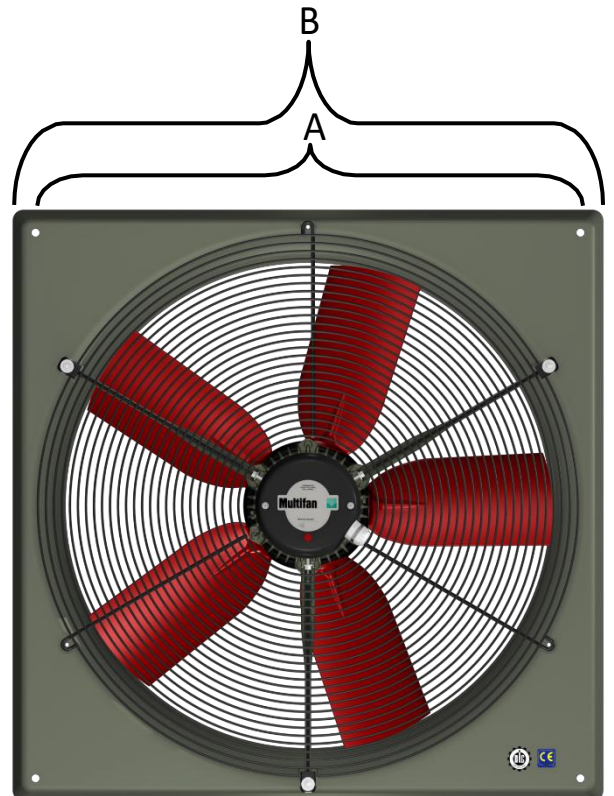
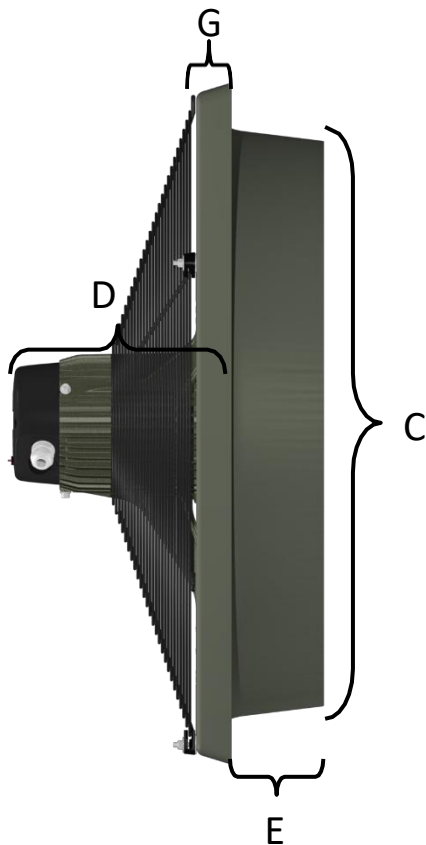



Viftur og stýringar fyrir gripahús

Leiðbeinandi tölur um loftskiptapörf í gripahúsum

		Þyngd gripa kg	Fjöldi VFE/grip	Hámarks loftskipti m ³ /klst/grip
Nautgripir	kálfar	50	0,12	25
		100	0,23	45
	geldneyti	200	0,42	85
		300	0,58	115
		400	0,72	145
	Mjólkurkýr	400	1,08	215
		500	1,16	230
Svín	smágrísir	15	0,08	25
		25	0,11	35
	sláturgrísir	50	0,17	50
		70	0,21	65
		90	0,24	70
	gyltur	175	0,25	75
	gyltur með smágrísi	175	0,44	130
Fuglar	holdakjúklingar	1,0	0,01	3
		1,5	0,012	3,5
	varphænur	2,5	0,013	4,0
Hestar		400	0,6	120
Sauðfé		60	0,12	25

Mælt er með því að loftskipti séu ekki oftar en 15 sinnum á klukkustund



Upplýsingar um SEA 5 og 10 Amp Prepastýringu

Prepastýringuna er hægt að nota eina og sér til að stýra hraðanum á viftunum. Einnig er hægt að hafa hana sjálfvirka og þarf þá að tengja hana við Multifan T15-4 Hitastýringu. Prepastýringin er með 6 stillingar á hraða. Sé hún notuð með hitanemanum er hraðinn stilltur á 5 og leitast stýringin að halda þeim hita í húsinu sem hitaneminn er stilltur á með því að auka eða minnka hraðann á viftunni.

Skilgreining	Min	Teg	Max	Einingar	Athugasemdir
Tegund stýringar					Prepastýring
Orka inn			3,15	A	Stærð öryggis 5x20mm
Rafmagnstenging	207	230	253	V	Eins fasa
Tíðni	50		60	Hz	
Orka út við 230 V					
Þrep 1		65		V	
Þrep 2		85		V	
Þrep 3		110		V	
Þrep 4		140		V	
Þrep 5		165		V	
Þrep 6		230		V	
Straumur út á viftu	0		3,15	A	
Kassi					IP55 plast
Þyngd		4,2		Kg	
Mál			140x237x115 mm		
Hitapól	0		40	°C	
Geymsluhiti	-15		50	°C	
Rakastig			95	%	

Multifan



Vrnr: MFEW5/ MFEW10

Hraðastýring EW5 Amp/EW 10 Amp



Vrnr: MFAEW10D

Hita og hraðastýring AEW 10D



Vrnr: MFSEA6.3A

Þrepastýring 3ja og 6 amp



Vrnr: MFT15-WD

Hitastýring



Vrnr: MFT15-2

Hitastýring T15-2



Vrnr: MFT15-4

Hitastýring T15-4



Birt með fyrirvara um verðbreytingar, dags. 24.4.2024